

## ESD protected common mode filter for USB3.2 interface

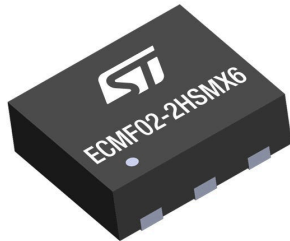

**μQFN-6L 1.7 X 1.5 mm**

Pin out, top view

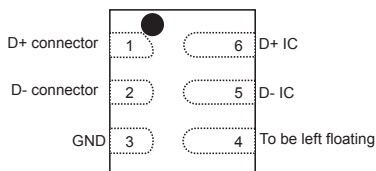

**Product status link**

[ECMF02-2HSMX6](#)

### Features

- High common mode attenuation:
  - -10 dB at 300 MHz
  - -20 dB at 2.4 and 5 GHz
  - -15 dB from 500 MHz to 6 GHz
- Compliant with USB3.2 gen 2 eye diagram
- Small and thin package 1.5 x 1.7 x 0.5 mm
- RoHS compliant
- High reduction of parasitic elements through integration
- ESD protection compliant with IEC 61000-4-2 level 4 standards (8 kV contact)

### Benefits

- Suppress the common mode noise but keep signal integrity
- Low PCB space consumption
- Save components count
- Make the application robust against ESD strikes from external environment

### Applications

Consumer and computer electronics featuring USB3.2 such as:

- Mobile phones
- Notebook, laptop
- Portable devices
- PND

### Description

The **ECMF02-2HSMX6** is a highly integrated common mode filter designed to suppress EMI/RFI common mode noise on high speed differential serial buses like USB3.2 transceiver.

# 1 Functional description

The ECMF02-2HSMX6 is an ESD protected common mode filter especially designed for USB3.2 Tx/Rx differential pair, for host and device. The USB3.2 is actually made of 3 differential pairs. The first differential pair supports the high speed USB mode (also called USB2.0 mode). The 2 other differential pairs are used to support the super speed USB mode in full duplex. Bit rate on super speed USB can reach 5 Gbps. The ECMF02-2HSMX6 is able to filter the common mode noise from 300 MHz to 6 GHz, helping to make the application compliant with the electromagnetic interference emission standard such as CISPR22 or FCC part 15, or EN55022 and avoiding antenna desense on mobile phones, WiFi/Bluetooth, GPS,/GNSS frequencies. At the same time, the ECMF02-2HSMX6 keeps the high speed signal integrity and provides an efficient ESD protection. More application information available in following AN:

- Application Note AN4356: "Antenna desense on handheld equipment"
- Application Note AN4511: "Common Mode filters"
- Application Note AN4540: "MHL link filtering and protection"

**Figure 1. Functional diagram**

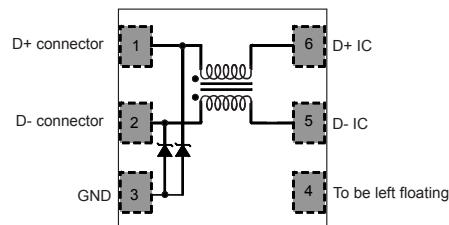

A typical application diagram is shown in Figure 2. ST offers a global approach to USB3.0 interface by providing a comprehensive range of dedicated products.

**Figure 2. Typical application diagram**

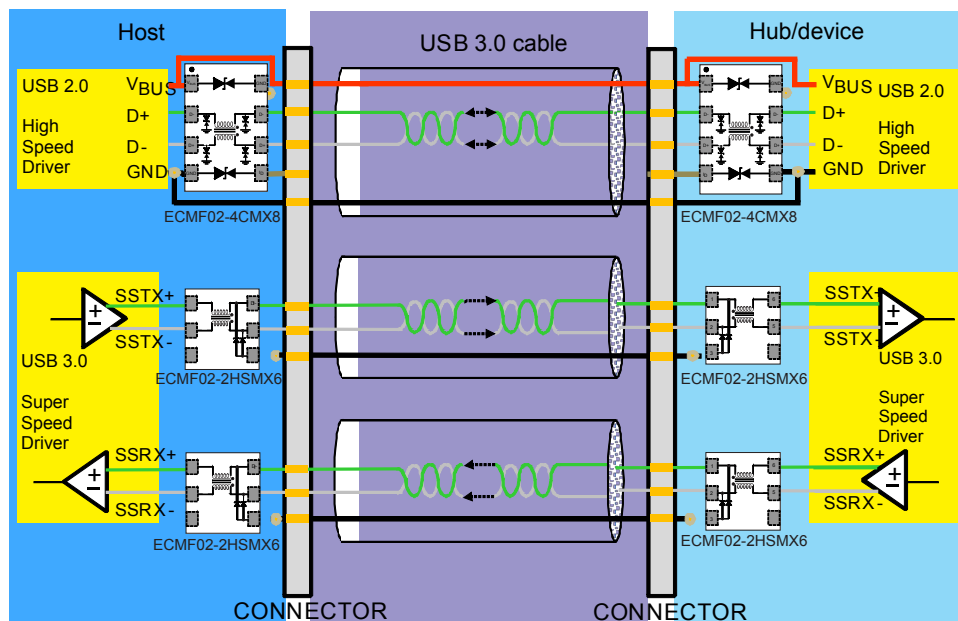

## 2 Characteristics

**Table 1. Absolute maximum ratings ( $T_{amb} = 25\text{ }^{\circ}\text{C}$ )**

Symbol	Parameter	Value	Unit	
$V_{PP}$	Peak pulse voltage	IEC 61000-4-2: Contact discharge	$\pm 8$	kV
		Air discharge	$\pm 15$	
$I_{DC}$	Maximum DC current	100	mA	
$T_{op}$	Operating ambient temperature range	-55 to +125	$^{\circ}\text{C}$	
$T_j$	Maximum junction temperature	+125		
$T_{stg}$	Storage temperature range	-55 to +150		

**Figure 3. Electrical characteristics (definitions)**

Symbol	Parameter
$V_{BR}$	Breakdown voltage
$I_{RM}$	Leakage current @ $V_{RM}$
$V_{RM}$	Stand-off voltage
$V_{CL}$	Clamping voltage at $I_{PP}$
$I_{PP}$	Peak pulse current
$I_F$	Forward current
$V_F$	Forward voltage

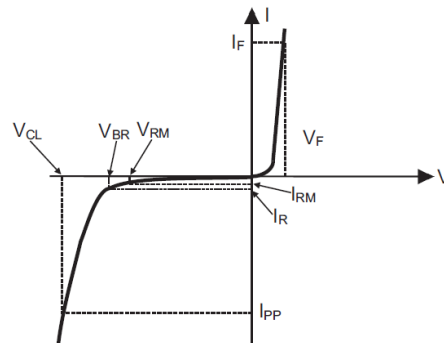

**Table 2. Electrical characteristics ( $T_{amb} = 25\text{ }^{\circ}\text{C}$ )**

Symbol	Test conditions	Min.	Typ.	Max.	Unit
$V_{BR}$	$I_R = 1\text{ mA}$	6			V
$I_{RM}$	$V_{RM} = 3\text{ V}$			100	nA
$R_{DC}$	DC serial resistance		7	9	$\Omega$

## 2.1 Characteristics (curves)

Figure 4 shows that USB3.0 devices and cables can interfere with radio frequency devices operating between 700 MHz and 5 GHz.

**Figure 4. USB3.2 frequency radiation measured with current loop**

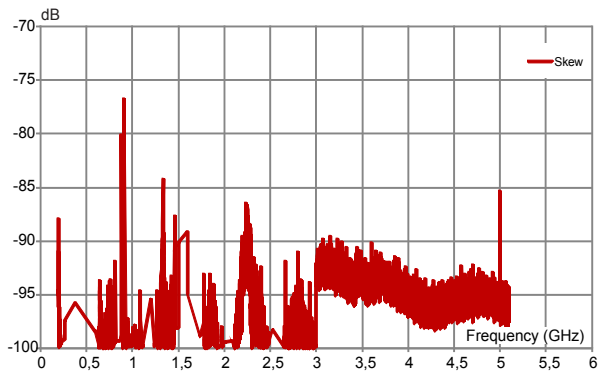

**Figure 5. Differential and common mode impedance versus frequency**

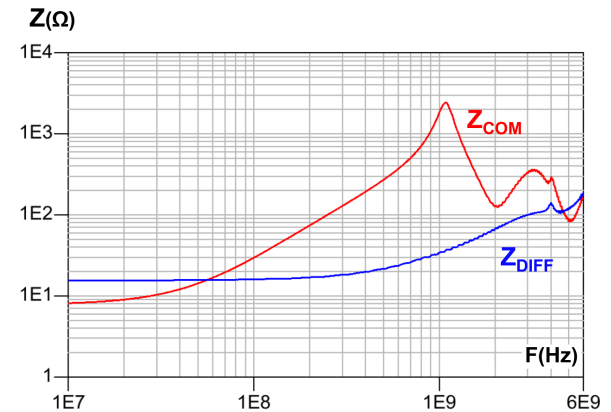

**Figure 6. Differential attenuation versus frequency**

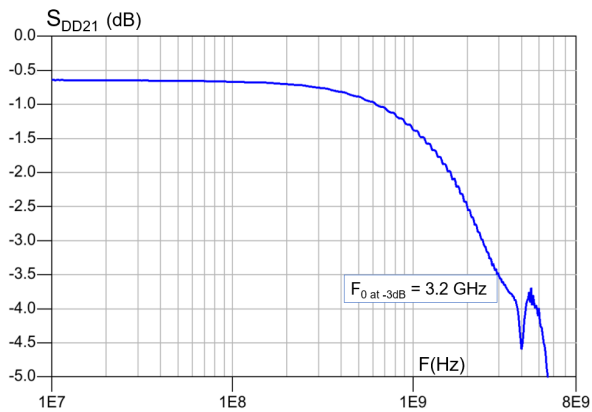

**Figure 7. Common mode attenuation versus frequency**

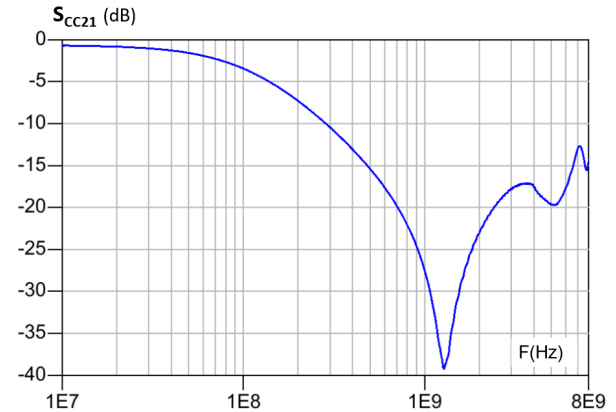

**Figure 8. Return loss versus frequency ( $Z_{0\text{ DIFF}} = 100\ \Omega$  -  $S_{DD11}$ )**

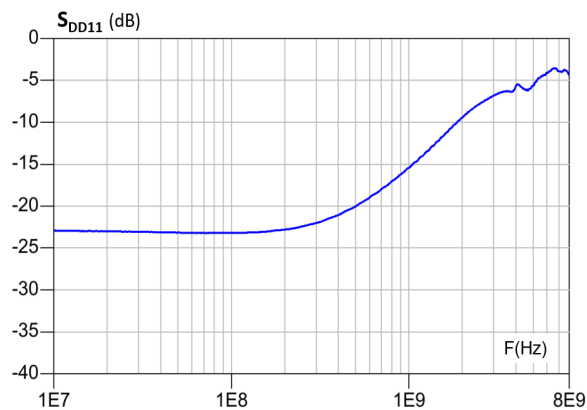

**Figure 9. Return loss versus frequency ( $Z_{0\text{ DIFF}} = 100\ \Omega$  -  $S_{DD22}$ )**

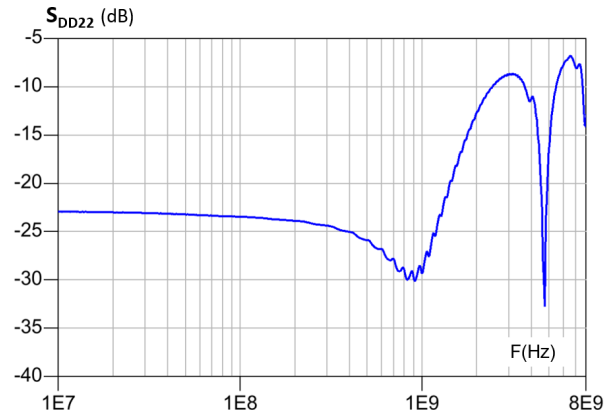

**Figure 10. Typical ESD response to IEC 61000-4-2 +8kV contact**

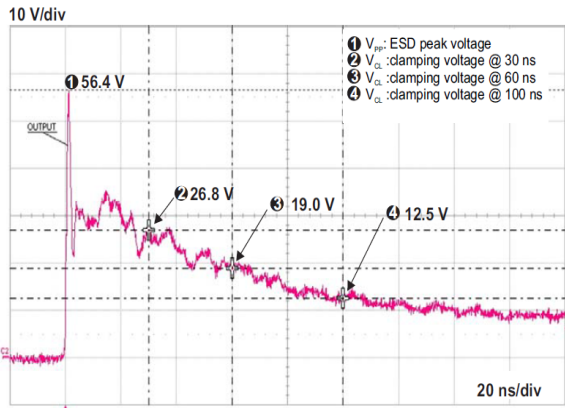

**Figure 11. Typical ESD response to IEC 61000-4-2 -8kV contact**

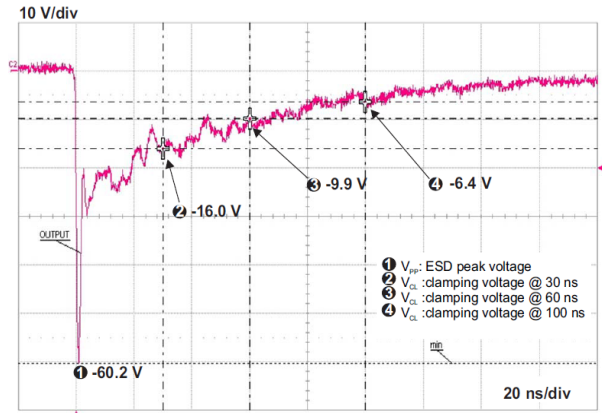

**Figure 12. USB2.0 (480 Mbps) eye diagram without device**

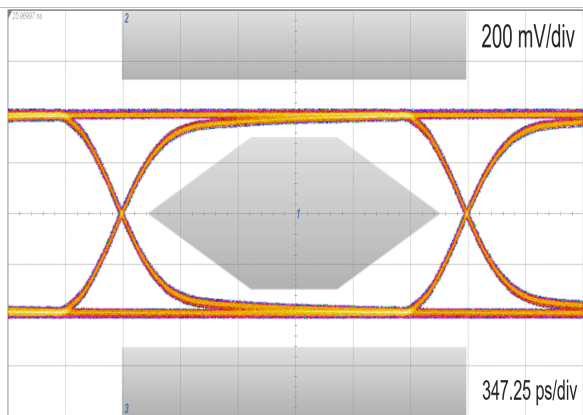

**Figure 13. USB2.0 (480 Mbps) eye diagram with device**

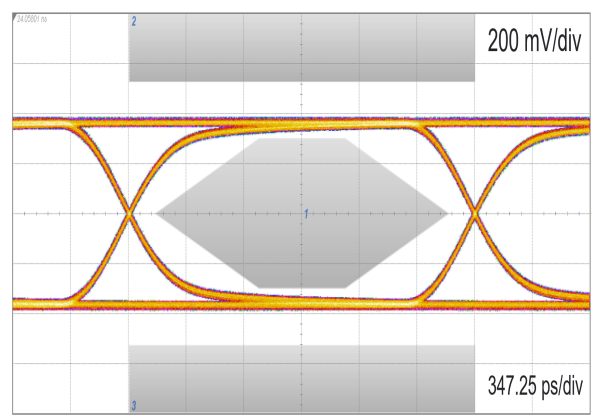

**Figure 14. USB 3.2 Gen 1 - 5.0 Gbps eye diagram without ECMF02-2HSMX6 (with type C connector, reference cable and equalizer)**

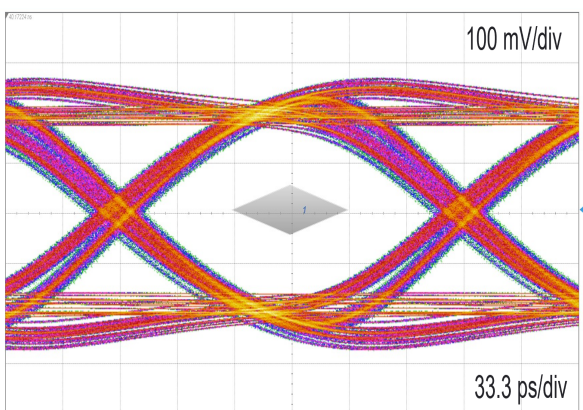

**Figure 15. USB 3.2 Gen 1 - 5.0 Gbps eye diagram with ECMF02-2HSMX6 (with type C connector, reference cable and equalizer)**

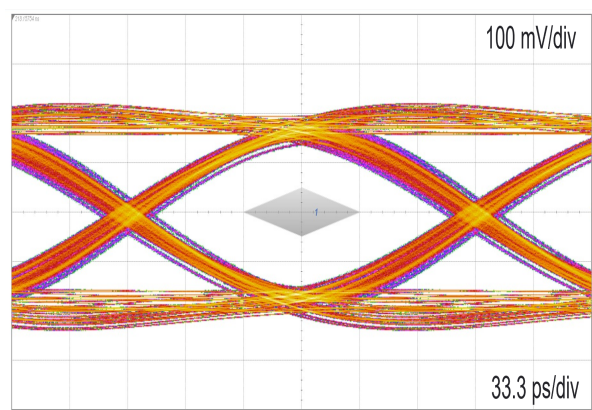

**Figure 16.** USB 3.2 Gen 2 - 10.0 Gbps eye diagram without ECMF02-2HSMX6 (with type C connector, reference cable, equalizer with ADC = 6 dB and DFE)

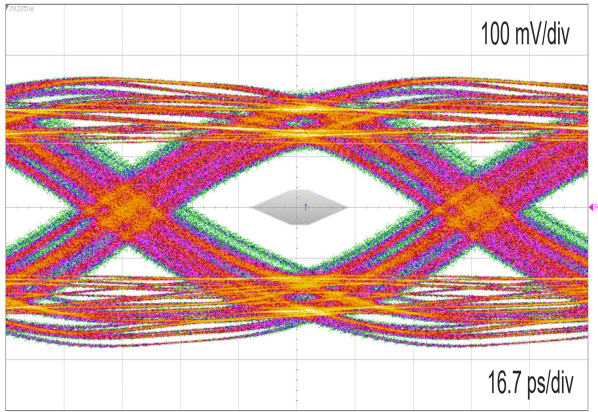

**Figure 17.** USB 3.2 Gen 2 - 10.0 Gbps eye diagram with ECMF02-2HSMX6 (with type C connector, reference cable, equalizer with ADC = 6 dB and DFE)

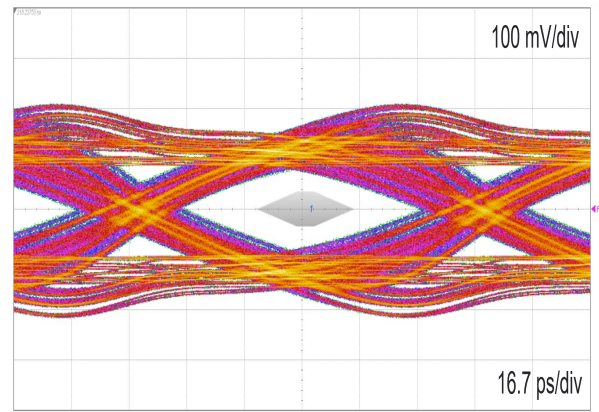

**Figure 18.** Display Port HBR2 5.4 Gbps eye diagram without ECMF02-2HSMX6

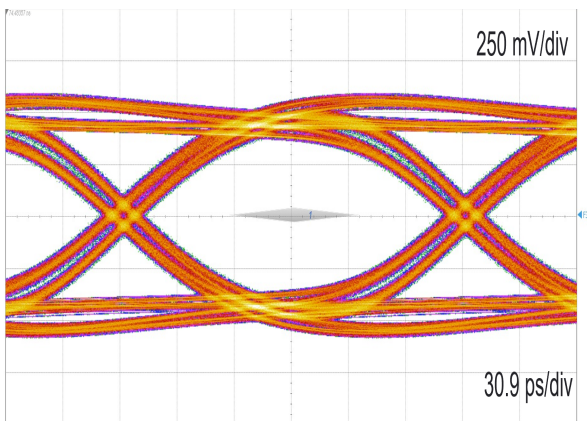

**Figure 19.** Display Port HBR2 5.4 Gbps eye diagram with ECMF02-2HSMX6

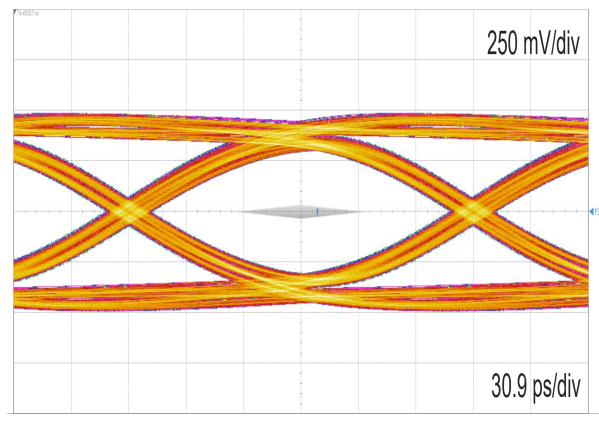

### 3 Package information

In order to meet environmental requirements, ST offers these devices in different grades of **ECOPACK** packages, depending on their level of environmental compliance. ECOPACK specifications, grade definitions and product status are available at: [www.st.com](http://www.st.com). ECOPACK is an ST trademark.

#### 3.1 QFN-6L package information

**Figure 20. QFN-6L package outline**

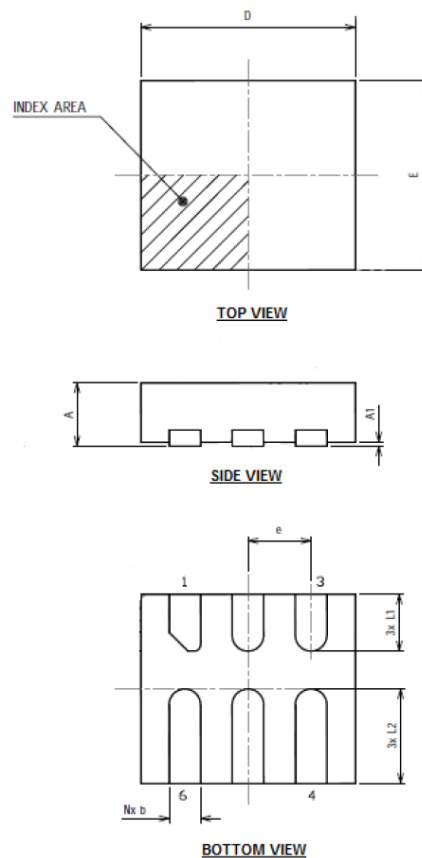

**Table 3. QFN-6L mechanical data**

Symbol	Dimensions (millimeters)		
	Min.	Typ.	Max.
A	0.45	0.50	0.55
A1	0.00	0.02	0.05
b	0.18	0.25	0.30
D	1.65	1.70	1.75
E	1.45	1.50	1.55
e	0.45	0.50	0.55
L1	0.35	0.45	0.55
L2	0.65	0.75	0.85

### 3.2 Packing information

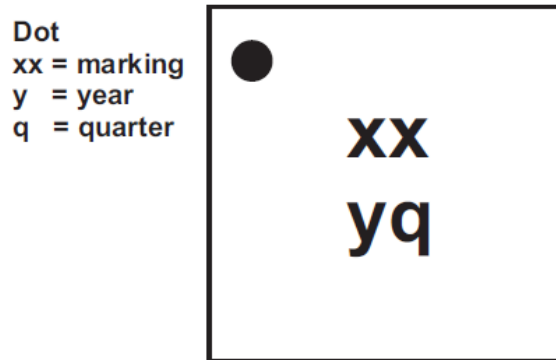
**Figure 21. Marking**

Note: The marking can be rotated to differentiate assembly location. Refer to [Table 4](#) for xx definition.

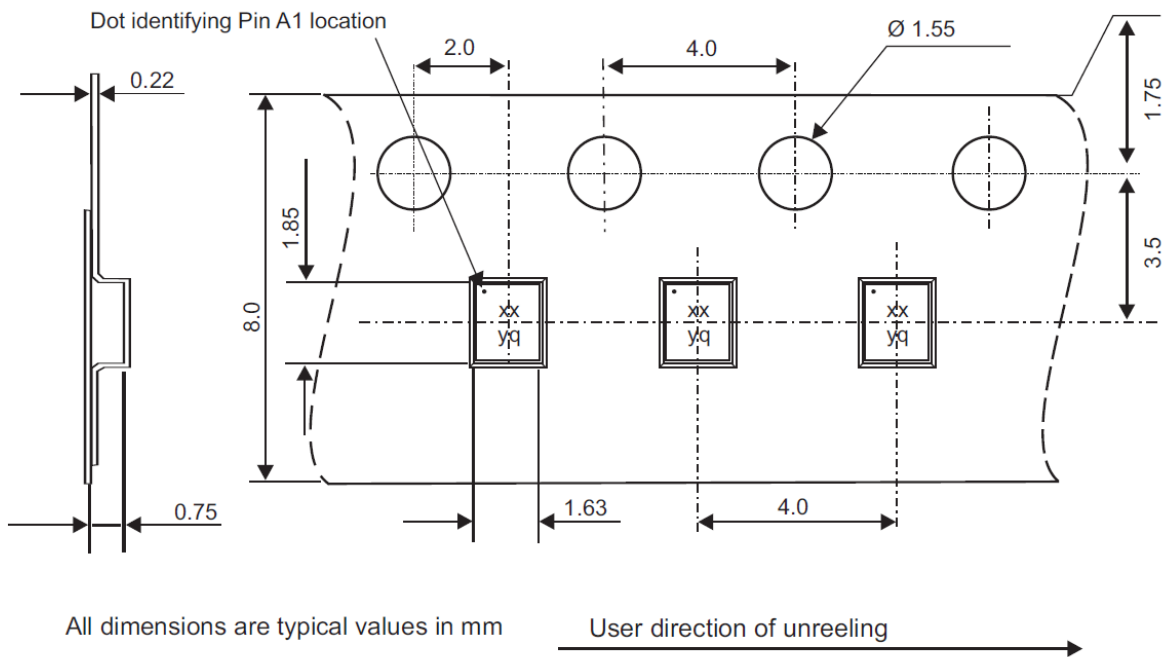
**Figure 22. Tape outline**



## 4 PCB assembly recommendation

### 4.1 Footprint

SMD footprint design is recommended.

Figure 23. Footprint in mm

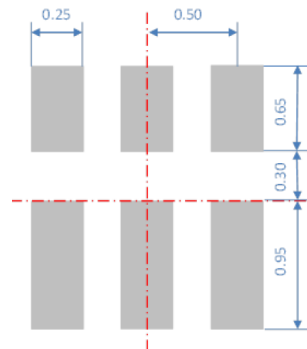

### 4.2 Stencil opening design

Stencil opening thickness: 100  $\mu\text{m}$

Figure 24. Stencil opening recommendations

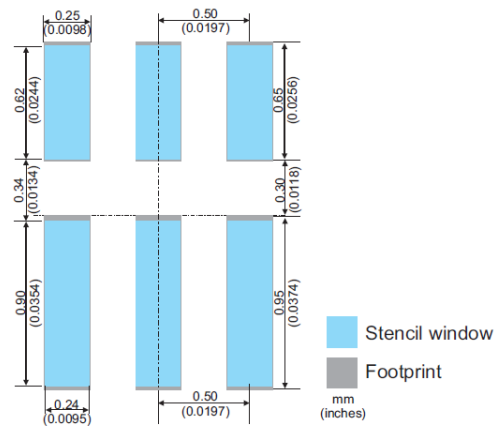

### 4.3 Solder paste

1. Halide-free flux, qualification ROL0 according to ANSI/J-STD-004.
2. "No clean" solder paste recommended.
3. Tack force high enough to resist component displacement during PCB movement.
4. Particles size 20-38  $\mu\text{m}$  per IPCJ STD-005.

#### 4.4 Placement

1. It is recommended to use leads recognition instead of package outline for accurate placement on footprint with adequate resolution tool.
2. Tolerance of  $\pm 50 \mu\text{m}$  (25% offset allowed on the smallest dimension of the smallest pad) is recommended.
3. 3.5 N placement force is recommended. Too much placement force can lead to squeezed out solder paste and cause solder joints to short. Too low placement force can lead to insufficient contact between package and solder paste that could cause open solder joints or badly centered packages.
4. For assembly, a perfect supporting of the PCB (all the more on flexible PCB) is recommended during solder paste printing, pick and place and reflow soldering by using optimized tools.

#### 4.5 PCB design preference

1. Any via around or inside the footprint area must be closed to avoid solderpaste migration in the via.
2. Position and dimensions of the tracks should be well balanced. A symmetrical layout is recommended to prevent assembly troubles.

#### 4.6 Reflow profile

**Figure 25. ST ECOPACK recommended soldering reflow profile for PCB mounting**

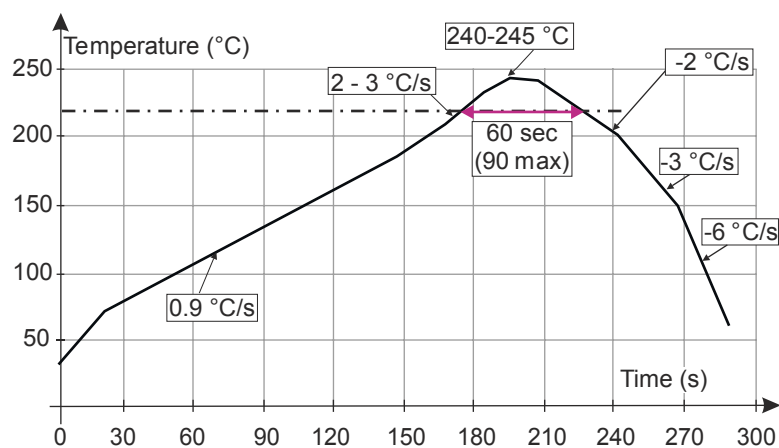

**Note:** Minimize air convection currents in the reflow oven to avoid component movement. Maximum soldering profile corresponds to the latest IPC/JEDEC J-STD-020.

## 5 Ordering information

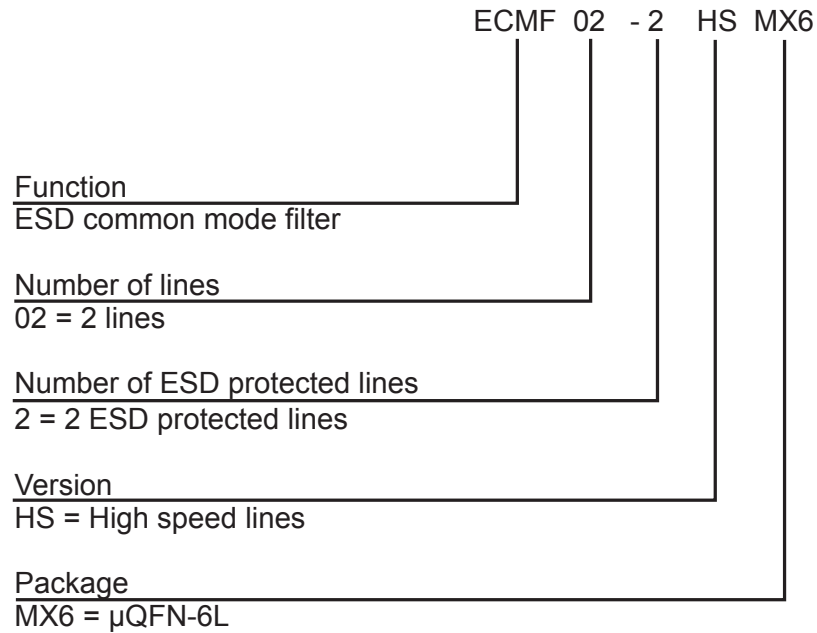
**Figure 26. Ordering information scheme**

**Table 4. Ordering information**

Order code	Marking	Package	Weight	Base qty.	Delivery mode
ECMF02-2HSMX6	KR	$\mu$ QFN-6L	3.4 mg	3000	Tape and reel

## Revision history

**Table 5. Document revision history**

Date	Version	Changes
13-Nov-2013	1	Initial release.
25-Aug-2014	2	Inserted Figure 10: Differential (ZDD21) and common mode (ZCC21) impedance versus frequency.
13-Dec-2017	3	Updated Table 1.
20-Dec-2021	4	Updated title description, <a href="#">Section 2.1 Characteristics (curves)</a> and removed PCB layout chapter. Minor text changes.

**IMPORTANT NOTICE – PLEASE READ CAREFULLY**

STMicroelectronics NV and its subsidiaries (“ST”) reserve the right to make changes, corrections, enhancements, modifications, and improvements to ST products and/or to this document at any time without notice. Purchasers should obtain the latest relevant information on ST products before placing orders. ST products are sold pursuant to ST’s terms and conditions of sale in place at the time of order acknowledgement.

Purchasers are solely responsible for the choice, selection, and use of ST products and ST assumes no liability for application assistance or the design of Purchasers’ products.

No license, express or implied, to any intellectual property right is granted by ST herein.

Resale of ST products with provisions different from the information set forth herein shall void any warranty granted by ST for such product.

ST and the ST logo are trademarks of ST. For additional information about ST trademarks, please refer to [www.st.com/trademarks](http://www.st.com/trademarks). All other product or service names are the property of their respective owners.

Information in this document supersedes and replaces information previously supplied in any prior versions of this document.

© 2021 STMicroelectronics – All rights reserved