

3GHz to 20GHz Microwave Mixer with Wideband DC to 6GHz IF

FEATURES

- Integrated LO Buffer: 0dBm LO Drive
- 50Ω Wideband Matched RF and LO Ports
- Wide IF Bandwidth: DC to 6GHz
- Upconversion or Downconversion
- High IIP3:
 - +22.5dBm at 10GHz
 - +18.3dBm at 17GHz
- +14.6dBm Input P1dB at 10GHz
- 8dB Conversion Loss at 10GHz
- 3.3V/132mA Supply
- Fast Turn ON/OFF for TDD Operation
- 3mm × 2mm, 12-Lead QFN Package

APPLICATIONS

- 5G Broadband Wireless Access
- Microwave Transceivers
- Wireless Backhaul
- Point-to-Point Microwave
- Phased-Array Antennas
- C, X and Ku Band RADAR
- Test Equipment
- Satellite Modems

LT, LT, LTC, LTM, Linear Technology and the Linear logo are registered trademarks of Analog Devices, Inc. All other trademarks are the property of their respective owners. Protected by U.S. patents, including 9312815.

DESCRIPTION

The LTC[®]5552 is a high performance, microwave double balanced passive mixer that can be used for frequency upconversion or downconversion. The device is similar to the LTC5553, but with a broadband, differential DC to 6GHz IF port. The LTC5552 is recommended for applications where the IF frequency range extends below 500MHz. For applications where the IF frequency is always above 500MHz, the LTC5553 is recommended, since it includes an integrated IF balun.

The mixer and integrated RF balun are optimized to cover the 3GHz to 20GHz RF frequency range. The integrated LO amplifier is optimized for the 1GHz to 20GHz frequency range, requiring only 0dBm drive.

The part delivers high IIP3 and P1dB, low LO leakage and high integration in a small package.

Electrostatic Sensitive Device

Observe Handling Precautions

ESD Sensitivity:

HBM = Class 0 on Pin 11

Class 1C All Other Pins

CDM = 500V All Pins

TYPICAL APPLICATION

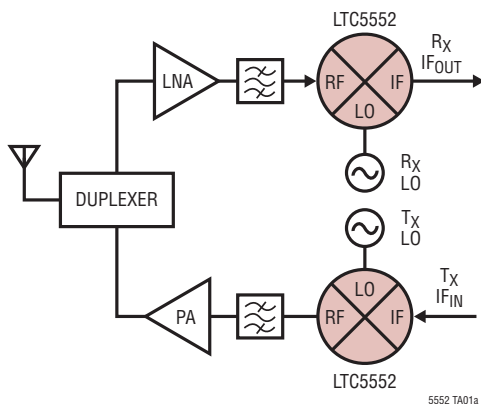

Conversion Loss and IIP3 vs RF Frequency (Low Side LO, IF = 240MHz)

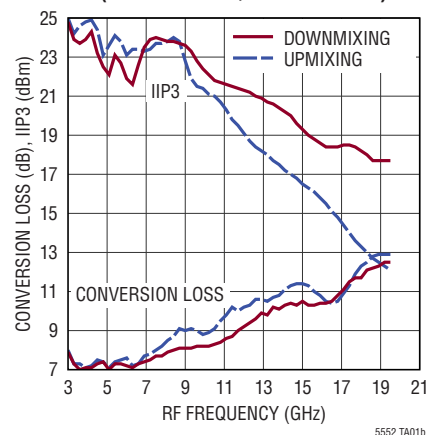

LTC5552

ABSOLUTE MAXIMUM RATINGS

(Note 1)

Supply Voltage (V_{CC})	4V
Enable Input Voltage (EN)	-0.3V to $V_{CC} + 0.3V$
LO Input Power (1GHz to 20GHz)	+10dBm
RF Power (3GHz to 20GHz)	+20dBm
RF DC Voltage	$\pm 0.1V$
IF ⁺ /IF ⁻ Power (LF to 6GHz)	+20dBm
IF ⁺ /IF ⁻ DC Voltage	$\pm 0.3V$
Operating Temperature Range (T_C)	-40°C to 105°C
Storage Temperature Range	-65°C to 150°C
Junction Temperature (T_J)	150°C

PIN CONFIGURATION

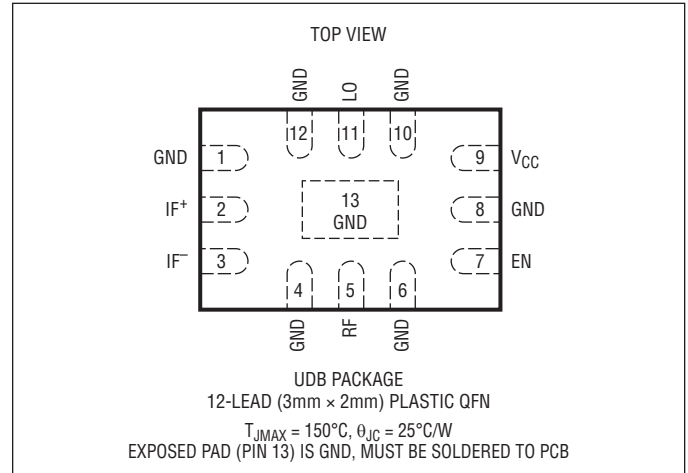

ORDER INFORMATION <http://www.linear.com/product/LTC5552#orderinfo>

Lead Free Finish

TAPE AND REEL (MINI)	TAPE AND REEL	PART MARKING	PACKAGE DESCRIPTION	CASE TEMPERATURE RANGE
LTC5552IUDB#TRMPBF	LTC5552IUDB#TRPBF	LHCK	12-Lead (3mm x 2mm) Plastic QFN	-40°C to 105°C

TRM = 500 pieces.

Consult LTC Marketing for parts specified with wider operating temperature ranges.

For more information on lead free part marking, go to: <http://www.linear.com/leadfree/>

For more information on tape and reel specifications, go to: <http://www.linear.com/tapeandreel/>. Some packages are available in 500 unit reels through designated sales channels with #TRMPBF suffix.

DC ELECTRICAL CHARACTERISTICS

The ● denotes the specifications which apply over the full operating temperature range, otherwise specifications are at $T_C = 25^\circ\text{C}$. $V_{CC} = 3.3V$, EN = High, unless otherwise noted. Test circuit shown in Figure 1. (Note 2)

PARAMETER	CONDITIONS	MIN	TYP	MAX	UNITS
Power Supply Requirements					
Supply Voltage (V_{CC})		● 3.0	3.3	3.6	V
Supply Current	EN = High		132	150	mA
Shutdown Current	EN = Low			100	μA
Enable (EN) Logic Input					
Input High Voltage (On)		● 1.2			V
Input Low Voltage (Off)		●		0.3	V
Input Current	-0.3V to $V_{CC} + 0.3V$		-30	100	μA
Chip Turn-On Time			0.2		μs
Chip Turn-Off Time			0.1		μs

5552f

AC ELECTRICAL CHARACTERISTICS The ● denotes the specifications which apply over the full operating temperature range, otherwise specifications are at $T_C = 25^\circ\text{C}$. $V_{CC} = 3.3\text{V}$, $EN = \text{High}$, $P_{LO} = 0\text{dBm}$, $P_{RF} = -6\text{dBm}$ ($-6\text{dBm}/\text{tone}$ for two-tone IIP3 tests), unless otherwise noted. Test circuit shown in Figure 1. (Notes 2, 3)

PARAMETER	CONDITIONS	MIN	TYP	MAX	UNITS
LO Frequency Range	●		1 to 20		GHz
RF Frequency Range	●		3 to 20		GHz
IF Frequency Range	●		DC to 6000		MHz
RF Return Loss	$Z_0 = 50\Omega$, 3GHz to 17GHz		>9		dB
LO Input Return Loss	$Z_0 = 50\Omega$, 1GHz to 20GHz		>10		dB
LO Input Power		-6	0	6	dBm

Downmixer Application, IF = 240MHz, Low Side LO

Conversion Loss	RF Input = 4GHz		6.9		dB
	RF Input = 10GHz		8.0		dB
	RF Input = 14GHz		10.0		dB
	RF Input = 17GHz		10.8		dB
Conversion Loss vs Temperature	$T_C = -40^\circ\text{C}$ to 105°C , RF Input = 10GHz	●	0.007		dB/ $^\circ\text{C}$
2-Tone Input 3rd Order Intercept ($\Delta f_{RF} = 2\text{MHz}$)	RF Input = 4GHz		23.8		dBm
	RF Input = 10GHz		22.5		dBm
	RF Input = 14GHz		20.1		dBm
	RF Input = 17GHz		18.3		dBm
SSB Noise Figure	RF Input = 10GHz		9.8		dB
	RF Input = 15.7GHz		11.7		dB
LO to RF Input Leakage	$f_{LO} = 1\text{GHz}$ to 20GHz		<-24		dBm
LO to IF Leakage	$f_{LO} = 1\text{GHz}$ to 20GHz		<-19		dBm
RF to LO Isolation	$f_{RF} = 3\text{GHz}$ to 20GHz		>53		dB
RF Input to IF Output Isolation	$f_{RF} = 3\text{GHz}$ to 20GHz		>34		dB
Input 1dB Compression	RF Input = 10GHz		14.6		dBm

Upmixer Application, IF = 240MHz, Low Side LO

Conversion Loss	RF Output = 4GHz		7.0		dB
	RF Output = 10GHz		8.6		dB
	RF Output = 14GHz		10.8		dB
	RF Output = 17GHz		10.6		dB
Conversion Loss vs Temperature	$T_C = -40^\circ\text{C}$ to 105°C , RF Output = 5.8GHz		0.007		dB/ $^\circ\text{C}$
2-Tone Input 3rd Order Intercept ($\Delta f_{IF} = 2\text{MHz}$)	RF Output = 4GHz		24.6		dBm
	RF Output = 10GHz		21.1		dBm
	RF Output = 14GHz		17.2		dBm
	RF Output = 17GHz		14.4		dBm
SSB Noise Figure	RF Output = 10GHz		9.9		dB
	RF Output = 15.7GHz		11.5		dB
LO to RF Output Leakage	$f_{LO} = 1\text{GHz}$ to 20GHz		<-24		dBm
LO to IF Input Leakage	$f_{LO} = 1\text{GHz}$ to 20GHz		<-19		dBm
IF to LO Isolation	$f_{IF} = 500\text{MHz}$ to 9GHz		>60		dB
IF Input to RF Output Isolation	$f_{IF} = 500\text{MHz}$ to 9GHz		>33		dB
Input 1dB Compression	RF Output = 10GHz		14.5		dBm

Note 1: Stresses beyond those listed under Absolute Maximum Ratings may cause permanent damage to the device. Exposure to any Absolute Maximum Rating condition for extended periods may affect device reliability and lifetime.

Note 2: The LTC5552 is guaranteed functional over the -40°C to 105°C case temperature range ($\theta_{JC} = 25^\circ\text{C}/\text{W}$).

Note 3: SSB noise figure measurements performed with a small-signal noise source, bandpass filter and 2dB matching pad on input, with bandpass filters on LO, and output.

TYPICAL PERFORMANCE CHARACTERISTICS EN = high, test circuit shown in Figure 1.

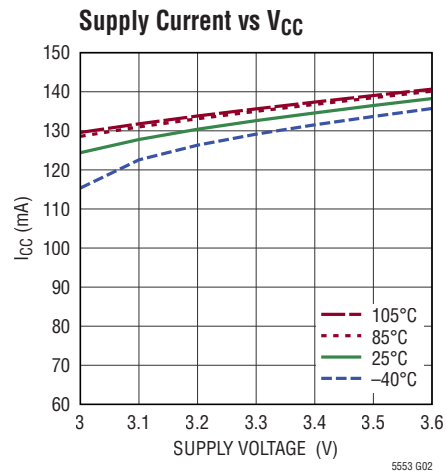
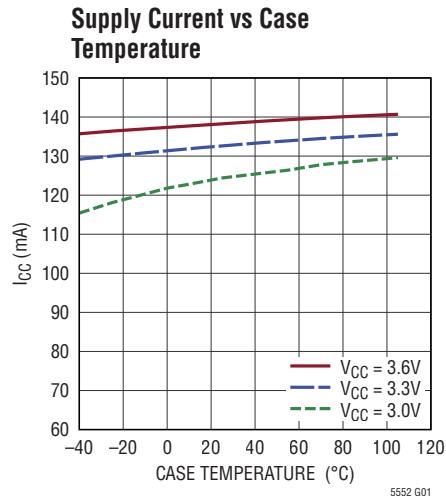

TYPICAL PERFORMANCE CHARACTERISTICS 3GHz to 20GHz downmixer application.

$V_{CC} = 3.3V$, $EN = \text{high}$, $T_C = 25^\circ C$, $P_{LO} = 0\text{dBm}$, $P_{IF} = -6\text{dBm}$ ($-6\text{dBm}/\text{tone}$ for two-tone IIP3 tests, $\Delta f = 2\text{MHz}$), $IF = 240\text{MHz}$, unless otherwise noted. Test circuit shown in Figure 1.

Conversion Loss and IIP3 vs Case Temperature (Low Side LO)

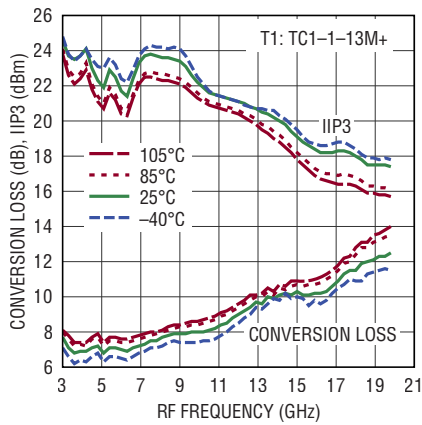

5552 G03

Conversion Loss and IIP3 vs LO Power (Low Side LO)

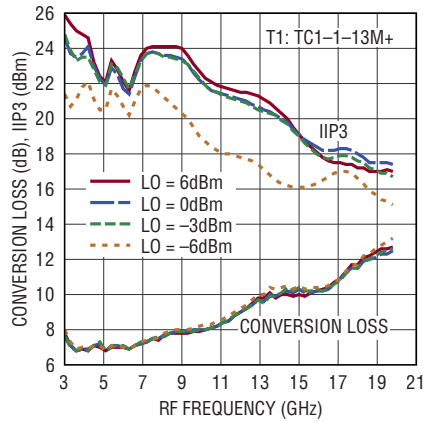

5552 G04

Conversion Loss and IIP3 vs Supply Voltage (Low Side LO)

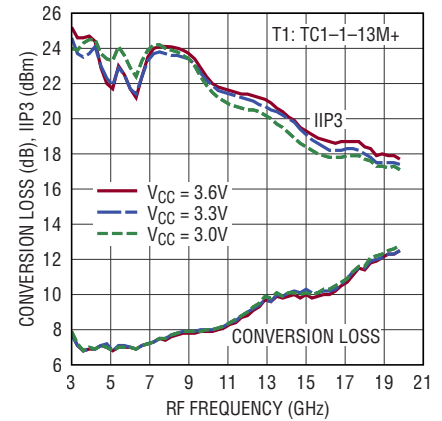

5552 G05

Conversion Loss and IIP3 vs Case Temperature (High Side LO)

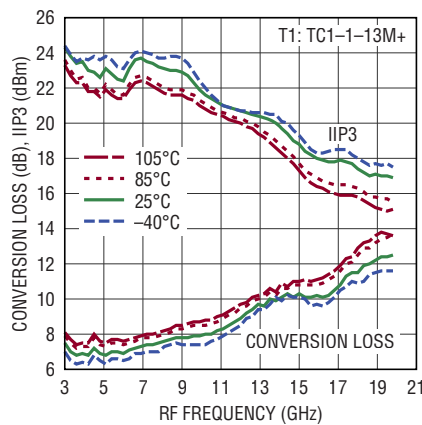

5552 G06

Conversion Loss and IIP3 vs LO Power (High Side LO)

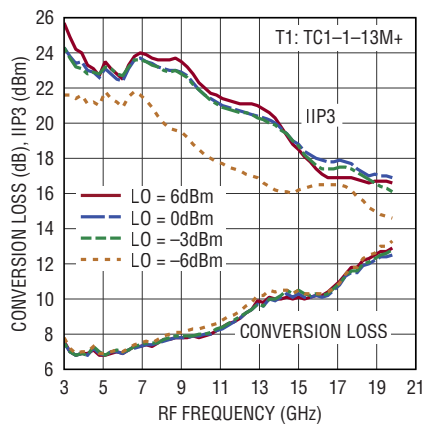

5552 G07

Conversion Loss and IIP3 vs Supply Voltage (High Side LO)

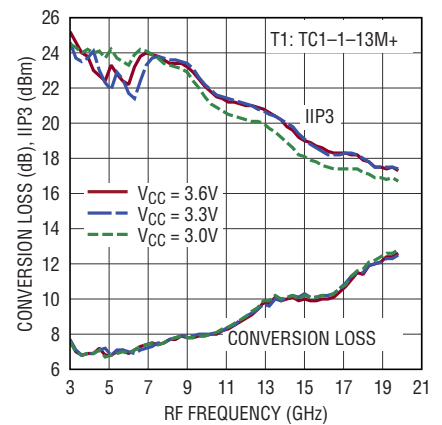

5552 G08

Conversion Loss and IIP3 vs Case Temperature (Low Side LO)

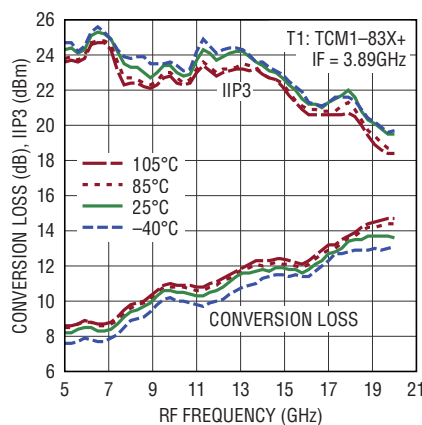

5552 G09

Conversion Loss and IIP3 vs LO Power (Low Side LO)

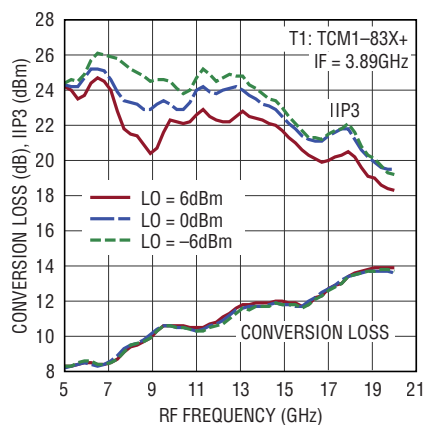

5552 G10

Conversion Loss and IIP3 vs Supply Voltage (Low Side LO)

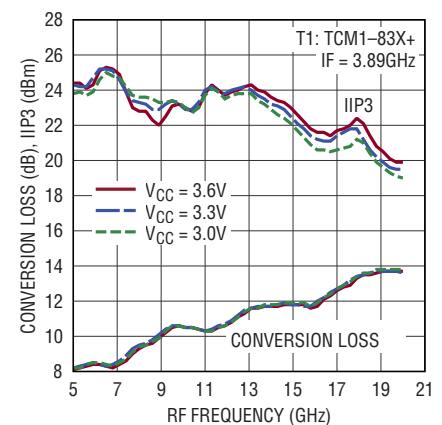

5552 G11

TYPICAL PERFORMANCE CHARACTERISTICS 3GHz to 20GHz downmixer application.

$V_{CC} = 3.3V$, EN = high, $T_C = 25^\circ C$, $P_{LO} = 0dBm$, $P_{IF} = -6dBm$ (-6dBm/tone for two-tone IIP3 tests, $\Delta f = 2MHz$), IF = 240MHz, unless otherwise noted. Test circuit shown in Figure 1.

Conversion Loss and IIP3 vs IF Frequency (RF = 10GHz)

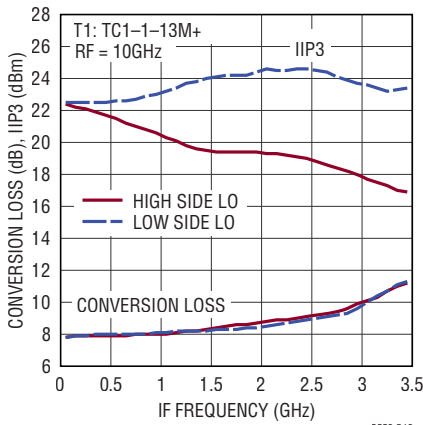

5552 G12

Conversion Loss and IIP3 vs IF Frequency (RF = 10GHz)

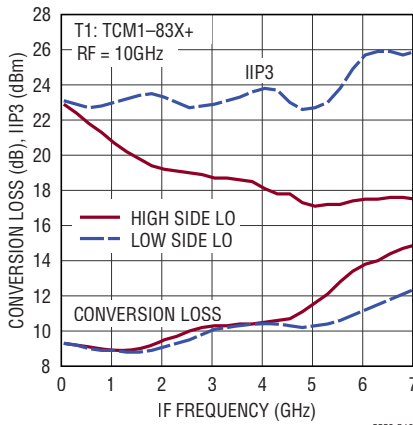

5552 G13

Input P1dB vs RF Frequency

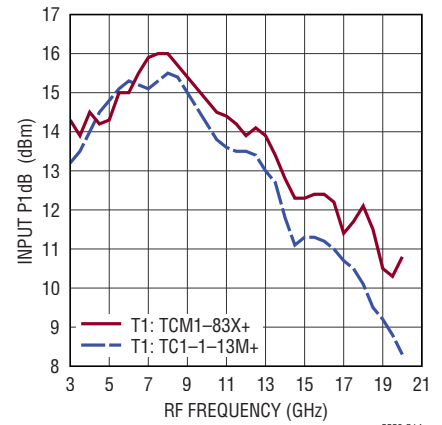

5552 G14

LO Leakage

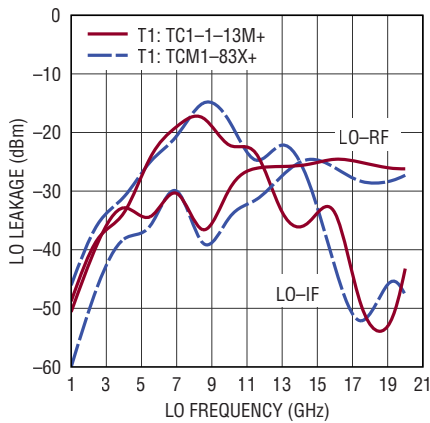

5552 G15

RF Isolation

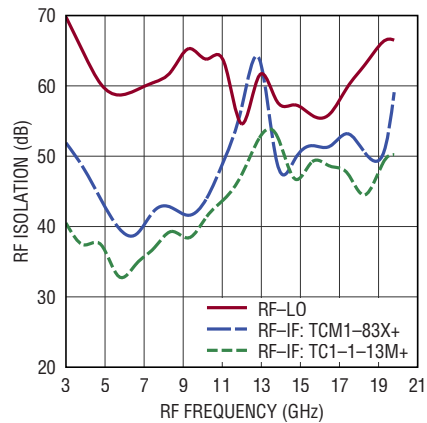

5552 G16

10GHz Conversion Loss Histogram

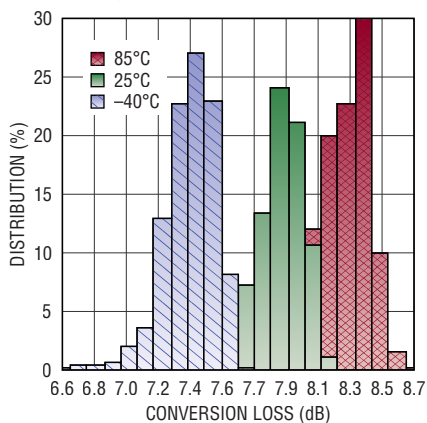

5552 G17

10GHz IIP3 Histogram

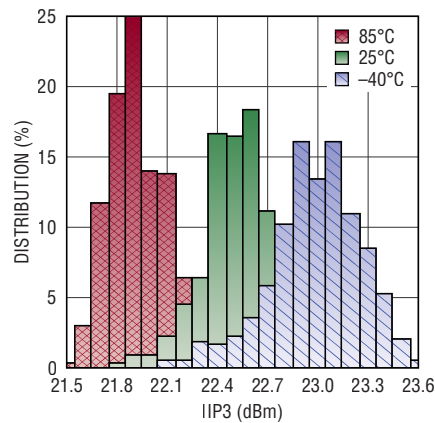

5552 G18

TYPICAL PERFORMANCE CHARACTERISTICS 3GHz to 20GHz upmixer application.
 $V_{CC} = 3.3V$, EN = high, $T_C = 25^\circ C$, $P_{LO} = 0dBm$, $P_{RF} = -6dBm$ (-6dBm/tone for two-tone IIP3 tests, $\Delta f = 2MHz$), IF = 240MHz, unless otherwise noted. Test circuit shown in Figure 1.

Conversion Loss and IIP3 vs Case Temperature (Low Side LO)

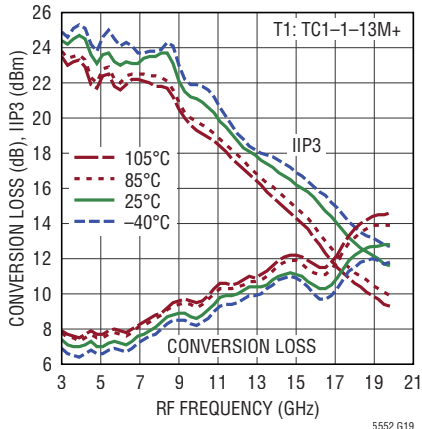

5552 G19

Conversion Loss and IIP3 vs LO Power (Low Side LO)

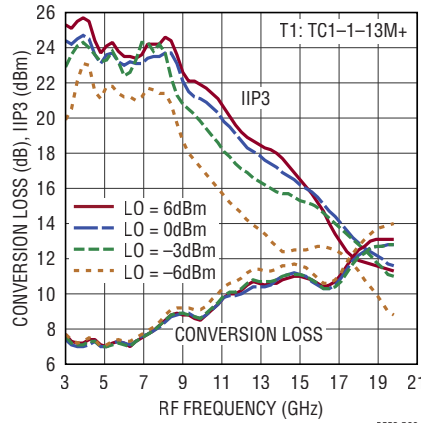

5552 G20

Conversion Loss and IIP3 vs Supply Voltage (Low Side LO)

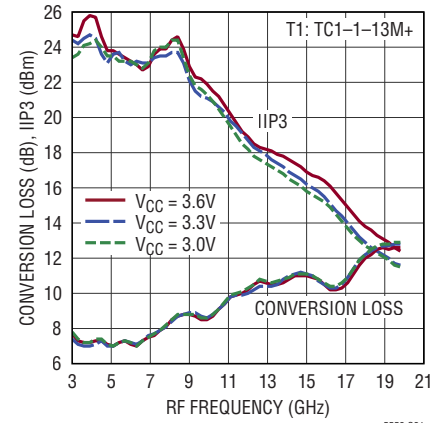

5552 G21

Conversion Loss and IIP3 vs Case Temperature (High Side LO)

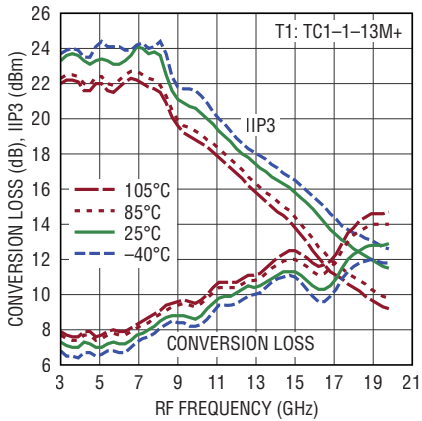

5552 G22

Conversion Loss and IIP3 vs LO Power (High Side LO)

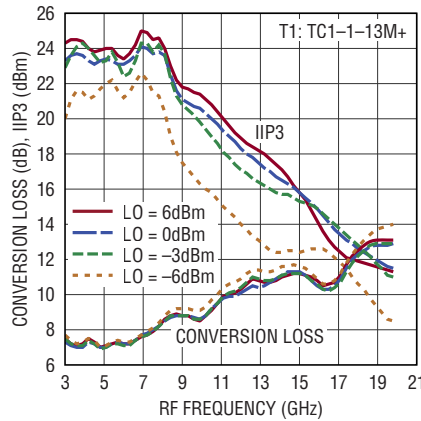

5552 G23

Conversion Loss and IIP3 vs Supply Voltage (High Side LO)

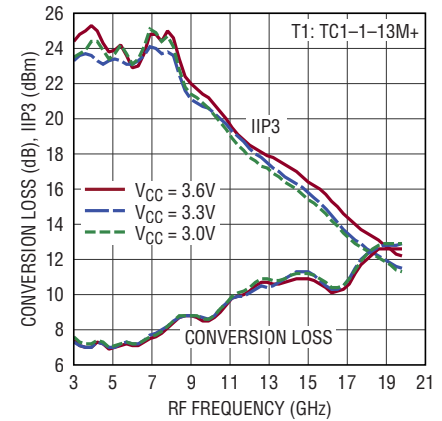

5552 G24

Conversion Loss and IIP3 vs Case Temperature (Low Side LO)

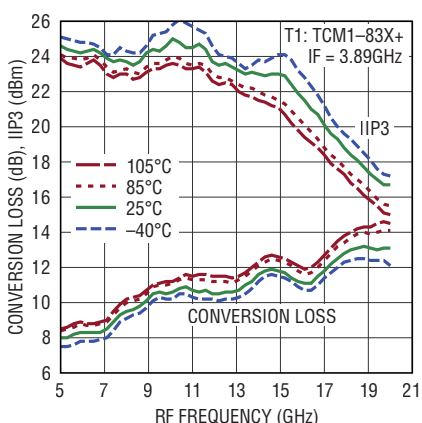

5552 G25

Conversion Loss and IIP3 vs LO Power (Low Side LO)

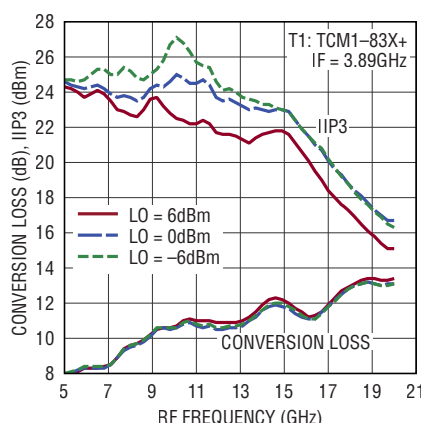

5552 G26

Conversion Loss and IIP3 vs Supply Voltage (Low Side LO)

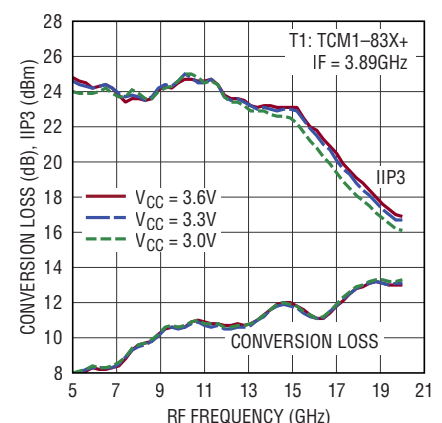

5552 G27

TYPICAL PERFORMANCE CHARACTERISTICS

3GHz to 20GHz upmixer application.

$V_{CC} = 3.3V$, $EN = \text{high}$, $T_C = 25^\circ C$, $P_{LO} = 0\text{dBm}$, $P_{RF} = -6\text{dBm}$ ($-6\text{dBm}/\text{tone}$ for two-tone IIP3 tests, $\Delta f = 2\text{MHz}$), $IF = 240\text{MHz}$, unless otherwise noted. Test circuit shown in Figure 1.

Conversion Loss and IIP3 vs IF Frequency (RF = 10GHz)

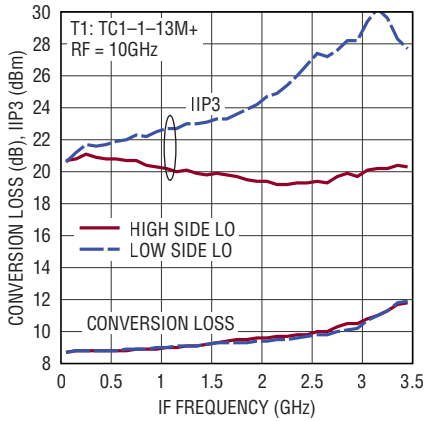

5552 G28

Conversion Loss and IIP3 vs IF Frequency (RF = 10GHz)

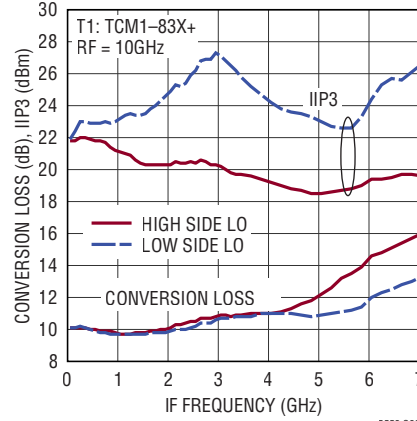

5552 G29

Input P1dB vs IF Frequency

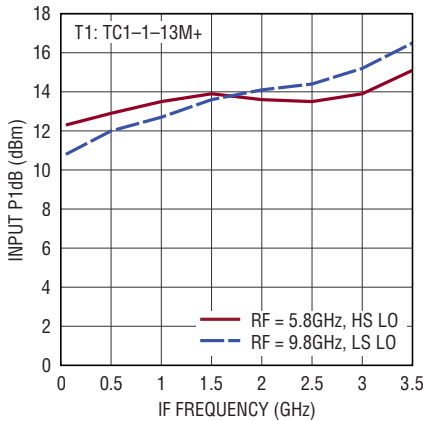

5552 G30

IF Isolation

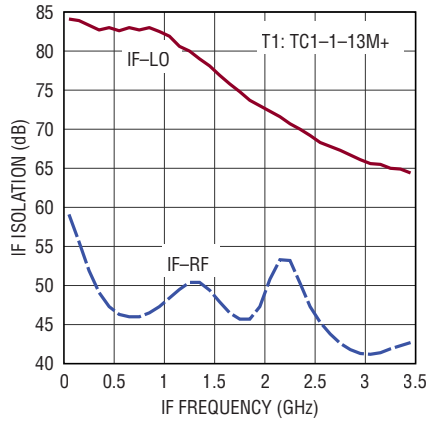

5552 G31

LO Leakage

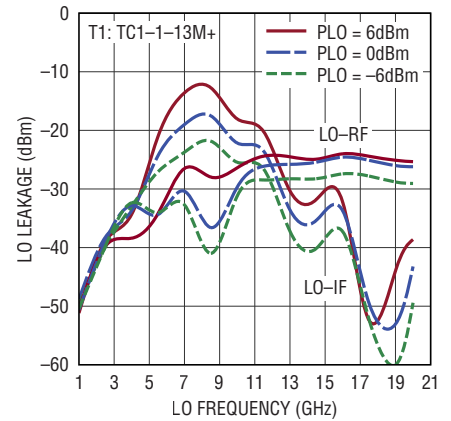

5552 G32

Input P1dB vs IF Frequency

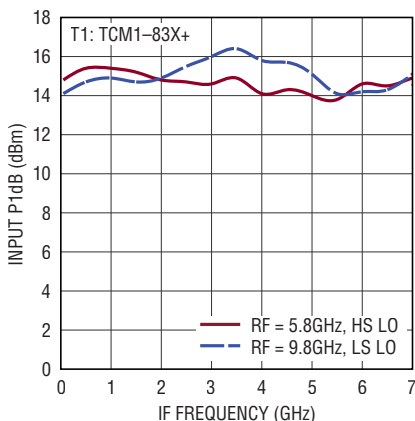

5552 G33

IF Isolation

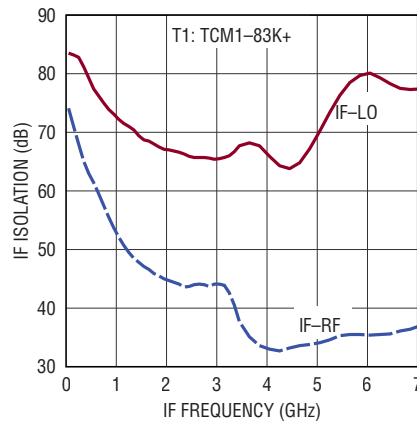

5552 G34

LO Leakage

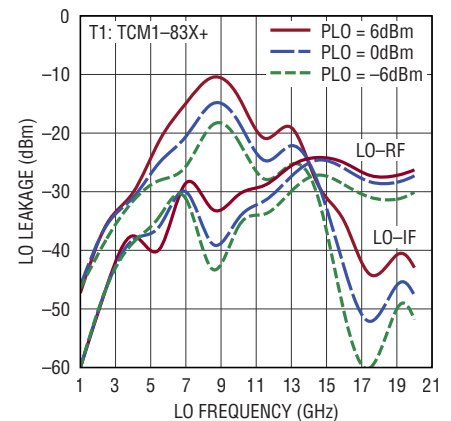

5552 G35

PIN FUNCTIONS

GND (Pins 1, 3, 4, 6, 8, 10, 12, Exposed Pad Pin 13): Ground. These pins must be soldered to the RF ground on the circuit board. The exposed pad metal of the package provides both electrical contact to ground and good thermal contact to the printed circuit board.

IF⁺, IF⁻ (Pins 2, 3): Differential Terminals for the IF. These pins may be used for a differential IF or connected to an external balun if a single-ended IF port is needed. The IF port can be used from DC up to 6GHz depending on the external balun bandwidth. DC voltages at IF⁺ and IF⁻ are 0V.

RF (Pin 5): Single-Ended Terminal for the RF Port. This pin is internally connected to the primary side of the RF transformer, which has low DC resistance to ground. A series DC blocking capacitor must be used to avoid damage

to the integrated transformer if DC voltage is present. The RF port is impedance matched from 3GHz to 20GHz as long as the LO is driven with a 0 ±6dBm source between 1GHz and 20GHz.

EN (Pin 7): Enable Pin. When the voltage applied to this pin is greater than 1.2V, the mixer is enabled. When the voltage is less than 0.3V, the mixer is disabled. Typical input current is less than 30µA. This pin has an internal 376kΩ pull-down resistor.

V_{CC} (Pin 9): Power Supply Pin. This pin must be externally connected to a regulated 3.3V supply, with a bypass capacitor located close to the pin. Typical current consumption is 132mA when the part is enabled.

LO (Pin 11): Input for the Local Oscillator (LO). A series DC blocking capacitor must be used. Typical DC voltage at this pin is 1.6V.

BLOCK DIAGRAM

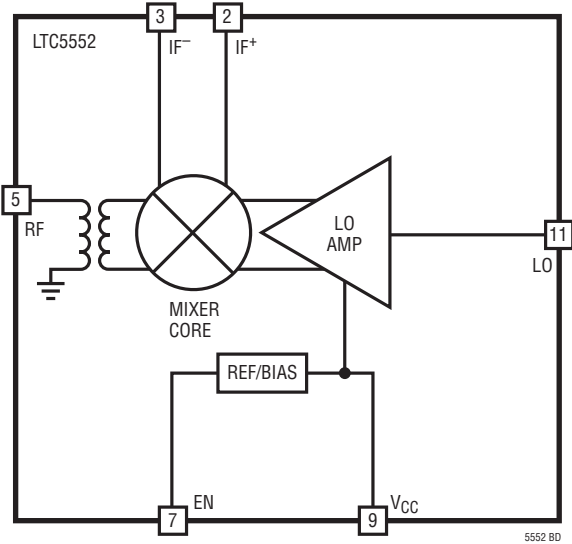

TEST CIRCUIT

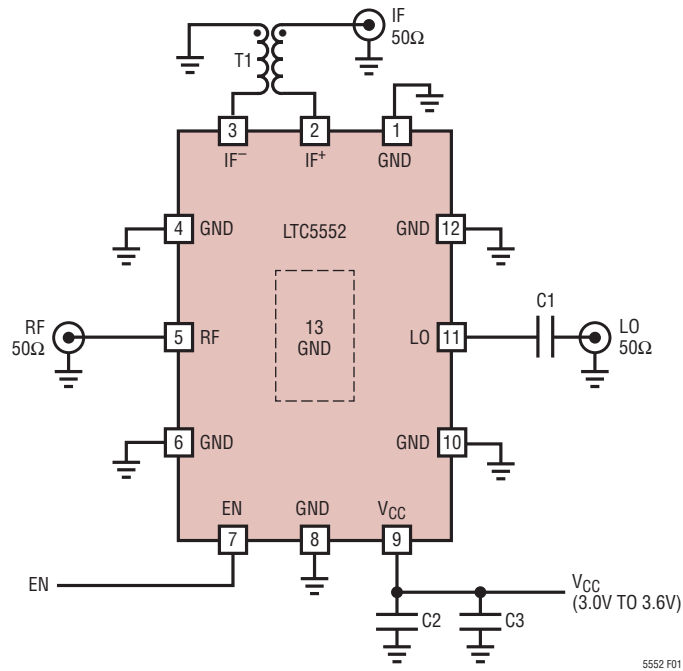

REF DES	VALUE	SIZE	VENDOR	COMMENT
C1	18pF	0402	AVX	0402ZK180GBS
C2	18pF	0402	Murata	GJM1555C1H180FB01
C3	1μF	0603	Murata	GRM188R71A105KA61
T1	TC1-1-13M+*		Mini Circuits	IF = 4.5MHz to 3GHz
	TCM1-83X+		Mini Circuits	IF = 10MHz to 6GHz

* Standard Evaluation Board Configuration

Figure 1. Standard Test Circuit Schematic

APPLICATIONS INFORMATION

Introduction

The LTC5552 consists of a high linearity double-balanced mixer core, LO buffer amplifier and bias/enable circuits. See the Block Diagram section for a description of each pin function. The RF and LO are single-ended 50Ω ports. The IF is differential. An external balun is needed if a single-ended IF signal is desired. The LTC5552 can be used as a frequency downconverter where the RF is used as an input and IF is used as an output. It can also be used as a frequency upconverter where the IF is used as an input and RF is used as an output. Low side or high side LO injection can be used. The evaluation circuit and the evaluation board layout are shown in Figure 1 and Figure 2, respectively.

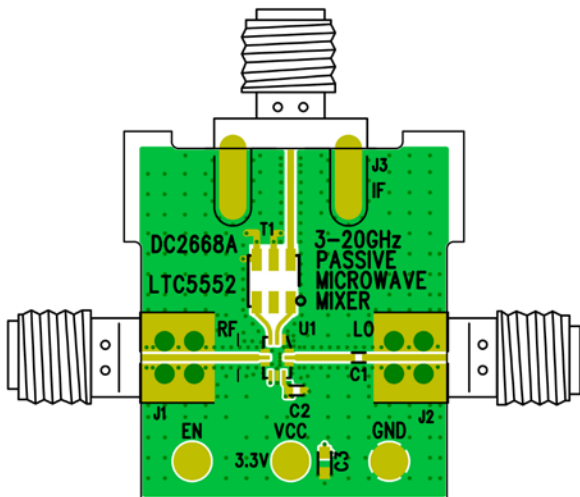

Figure 2. Evaluation Board Layout

RF Port

The mixer’s RF port, shown in Figure 3, is connected to the primary winding of an integrated transformer. The primary side of the RF transformer is DC-grounded internally and

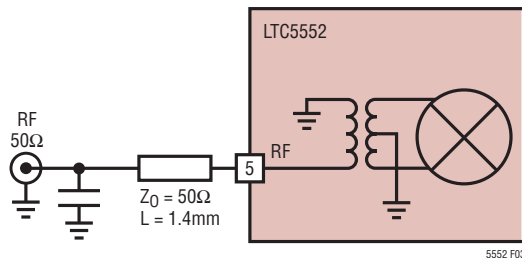
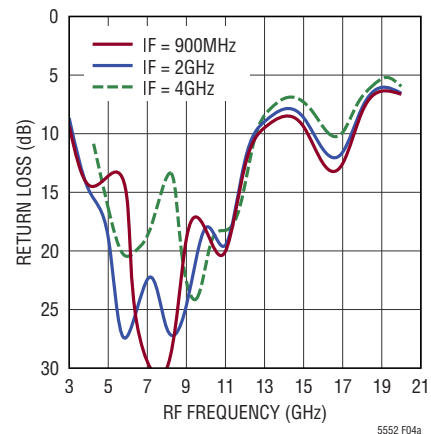

Figure 3. Simplified RF Port Interface Schematic

the DC resistance of the primary side is approximately 2.5Ω. A DC blocking capacitor is needed if the RF source has DC voltage present. The secondary winding of the RF transformer is internally connected to the mixer core.

The RF port is internally broadband matched from 3GHz to 20GHz. A 0.15pF shunt capacitor located 1.4mm away from the RF pin can be used to improve the RF port matching between 13GHz to 15GHz. LO power between -6dBm and 6dBm is required for good RF impedance matching. The measured RF input return loss is shown in Figure 4 for IF frequencies of 900MHz, 2GHz and 4GHz with low side LO.



(a) No Matching

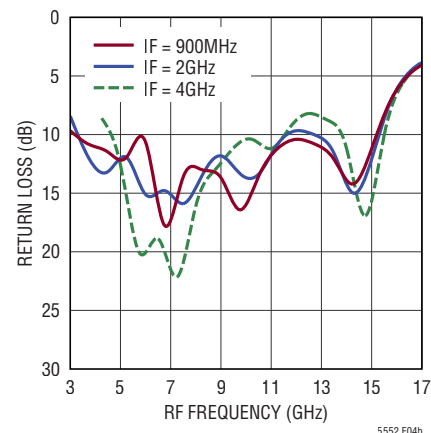

(b) With Shunt 0.15pF at 1.4mm

Figure 4. RF Port Return Loss

APPLICATIONS INFORMATION

The RF input impedance and input reflection coefficient versus RF frequency is listed in Table 1. The reference plane for this data is Pin 5 of the IC, with no external matching, and the LO is driven at 12GHz.

Table 1. RF Port Impedance and S11 (at Pin 5, No External Matching, LO Input Driven at 12GHz)

FREQUENCY (GHz)	RF INPUT IMPEDANCE	S11	
		MAG	ANGLE
3	50.1 + j33.8	0.32	71.3
4	63.3 + j37.1	0.33	52.1
5	96.2 + j14.7	0.33	11.9
6	75.4 + j16.6	0.24	-25.6
7	54.9 + j18.5	0.18	-65.2
8	37.5 - j8.2	0.17	-141.2
9	39.7 - j3.0	0.12	161.7
10	44.7 - j4.1	0.07	-140.7
11	45.2 - j10.4	0.12	-108.4
12	38.9 - j16.5	0.22	-113.4
13	32.5 - j22.1	0.33	-113.3
14	28.1 - j24.3	0.40	-114.7
15	30.1 - j22.2	0.36	-116.4
16	27.6 - j13.1	0.33	-140.0
17	24.8 + j3.1	0.34	170.5
18	19.8 + j18.9	0.47	141.8
19	17.0 + j19.6	0.55	132.9
20	21.3 + j19.6	0.47	130.2

LO Input

The mixer's LO input, shown in Figure 5, consists of a single-ended to differential conversion and high speed limiting differential amplifier. The LO amplifier is optimized for the 1GHz to 20GHz LO frequency range. LO frequencies above or below this frequency range may be used with degraded performance.

The DC voltage at the LO input is about 1.6V. A DC blocking capacitor (C1) is required.

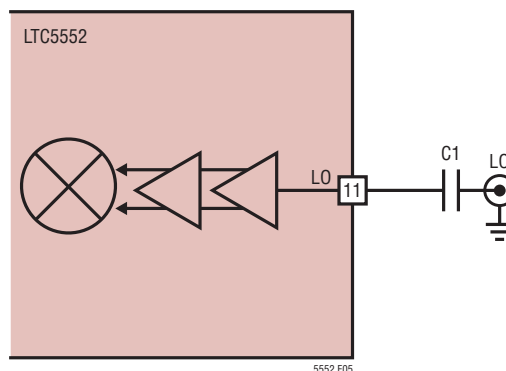

Figure 5. Simplified LO Input Schematic

The LO is 50Ω matched from 1GHz to 20GHz. External matching components may be needed for extended LO operating frequency range. To ensure the best LO impedance matching over the very wide bandwidth, no ESD protection devices are used at the LO input. As a result, the LO is the most sensitive pin to ESD stress for the mixer. The measured LO input return loss is shown in Figure 6. The nominal LO input level is 0dBm, although the limiting amplifiers will deliver excellent performance over a ±6dBm input power range.

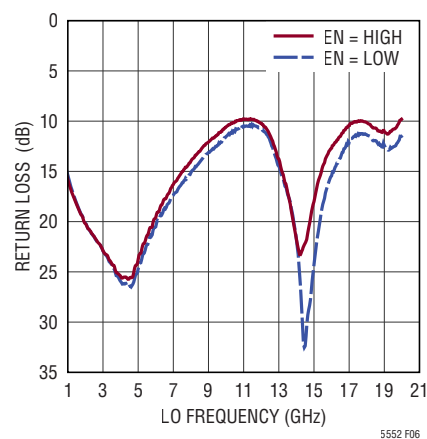

Figure 6. LO Input Return Loss

The LO input impedance and input reflection coefficient versus frequency, is shown in Table 2.

APPLICATIONS INFORMATION

Table 2. LO Input Impedance vs Frequency
(at Pin 11, No External Matching with C1 = 18pF Connected)

FREQUENCY (GHz)	INPUT IMPEDANCE	S11	
		MAG	ANGLE
1	56.3 – j18.0	0.18	-61.0
2	54.1 – j12.3	0.12	-64.7
3	55.1 – j9.7	0.10	-56.8
4	57.9 – j6.1	0.09	-34.4
5	56.1 – j3.5	0.07	-28.0
6	50.4 – j3.0	0.03	-80.6
7	43.4 – j5.7	0.09	-135.4
8	39.3 – j10.7	0.17	-128.2
9	37.1 – j15.8	0.23	-119.0
10	34.8 – j20.2	0.29	-113.6
11	34.4 – j22.1	0.31	-110.6
12	36.8 – j21.3	0.28	-108.0
13	39.8 – j16.2	0.21	-111.9
14	38.1 – j7.4	0.16	-143.5
15	32.9 – j2.7	0.21	-169.3
16	23.9 – j7.1	0.36	-159.4
17	20.1 – j11.4	0.45	-150.0
18	21.6 – j15.4	0.44	-139.4
19	26.9 – j14.8	0.35	-136.5
20	28.4 – j7.4	0.29	-155.9

IF Port

The mixer’s IF port is differential as shown in Figure 7. ESD protection diodes are connected to both of these ports. The single-ended impedance of each of the IF⁺ and IF⁻ terminals is approximately 25Ω in parallel with 0.25pF. An external 1:1 balun is required for a 50Ω single-ended IF. Using a TC1-1-13M⁺ balun, for example, the IF port is broadband matched from 4.5MHz to 3GHz, when the LO

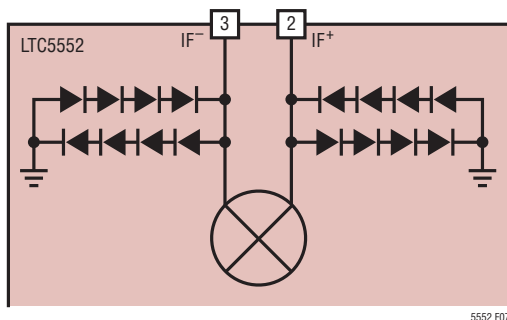

Figure 7. Simplified IF Port Schematic

is applied. For higher frequency IF operation, up to 6GHz, the TCM1-83X⁺ balun is recommended.

The measured IF port return loss is shown in Figure 8.

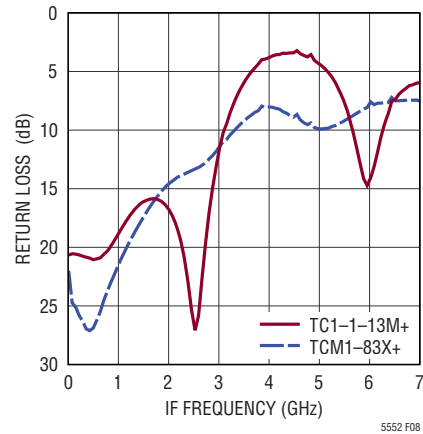

Figure 8. IF Port Return Loss

Enable Interface

Figure 9 shows a simplified schematic of the EN pin interface. To enable the chip, the EN voltage must be higher than 1.2V. The voltage at the EN pin should never exceed V_{CC} by more than 0.3V. If this should occur, the supply current could be sourced through the ESD diode, potentially damaging the IC. If the EN pin is left floating, its voltage will be pulled low by the internal pull-down resistor and the chip will be disabled.

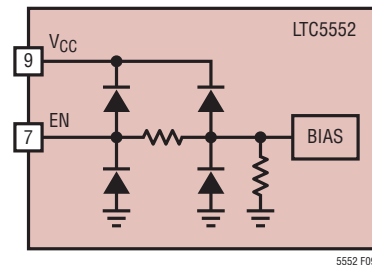

Figure 9. Simplified Enable Input Circuit

APPLICATIONS INFORMATION

Supply Voltage Ramping

Fast ramping of the supply voltage can cause a current glitch in the internal ESD protection circuits. Depending on the supply inductance, this could result in a supply voltage transient that exceeds the maximum rating. A supply voltage ramp time of greater than 1ms is recommended.

Spurious Output Levels

Mixer spurious output levels versus harmonics of the RF and LO are tabulated in Table 3 and Table 4. The spur levels were measured on a standard evaluation board using the test circuit shown in Figure 1. The spur frequencies can be calculated using the following equation:

$$\text{Frequency Downconversion: } f_{\text{SPUR}} = (M \cdot f_{\text{RF}}) \pm (N \cdot f_{\text{LO}})$$

$$\text{Frequency Upconversion: } f_{\text{SPUR}} = (M \cdot f_{\text{IF}}) \pm (N \cdot f_{\text{LO}})$$

Table 3. IF Output Spur Levels (dBc) – Downmixer Diff Frequency

RF = 5250MHz, P_{RF} = -6dBm, P_{LO} = 0dBm, IF = 251MHz, Low Side LO, V_{CC} = 3.3V, EN = High, T_C = 25°C

		N					
		0	1	2	3	4	5
M	0		-26	-74	-73	*	*
	1	-13	0	-57	-70	-74	*
	2	-8	-38	-73	-69	< -75	-74
	3	-34	-17	-60	-59	< -75	< -75
	4	*	-61	-71	-74	< -75	< -75
	5	*	*	*	-65	< -75	< -75

* Out of the test equipment range.

Table 4. RF Output Spur Levels (dBc) – Upmixer Sum Frequency

RF = 5399MHz, P_{RF} = -6dBm, P_{LO} = 0dBm, IF = 400MHz, Low Side LO, V_{CC} = 3.3V, EN = High, T_C = 25°C

		N				
		0	1	2	3	4
M	0		-25	-19	-26	-20
	1	-41	0	-38	-14	*
	2	-65	-63	-62	-62	*
	3	< -75	-66	-70	-65	*
	4	< -75	< -75	< -75	-73	*
	5	< -75	< -75	< -75	-73	*
	6	< -75	< -75	< -75	-74	*
	7	< -75	< -75	< -75	-74	*

* Out of the test equipment range.

APPLICATIONS INFORMATION

Evaluation Board Insertion Loss

The LTC5552 performance in the data sheet is measured using the evaluation board shown in Figure 2. The insertion loss of the board traces and SMA connectors are

not de-embedded. These insertion losses are shown in Figure 10, and the actual performance of the LTC5552 can be estimated using this data. Figure 11 compares the de-embedded performance to the performance measured at the SMA connectors.

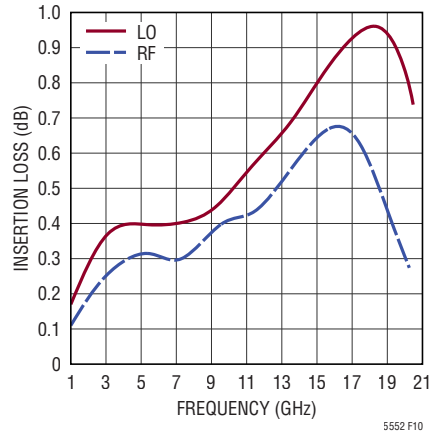

Figure 10. Insertion Loss of the RF and LO ports

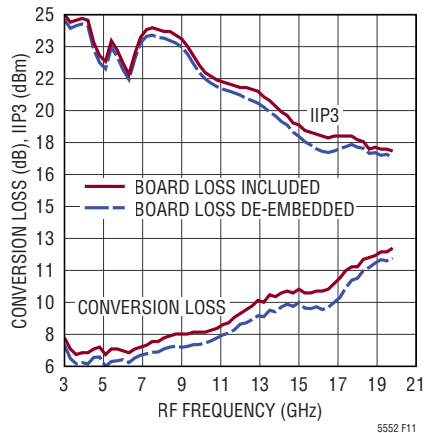
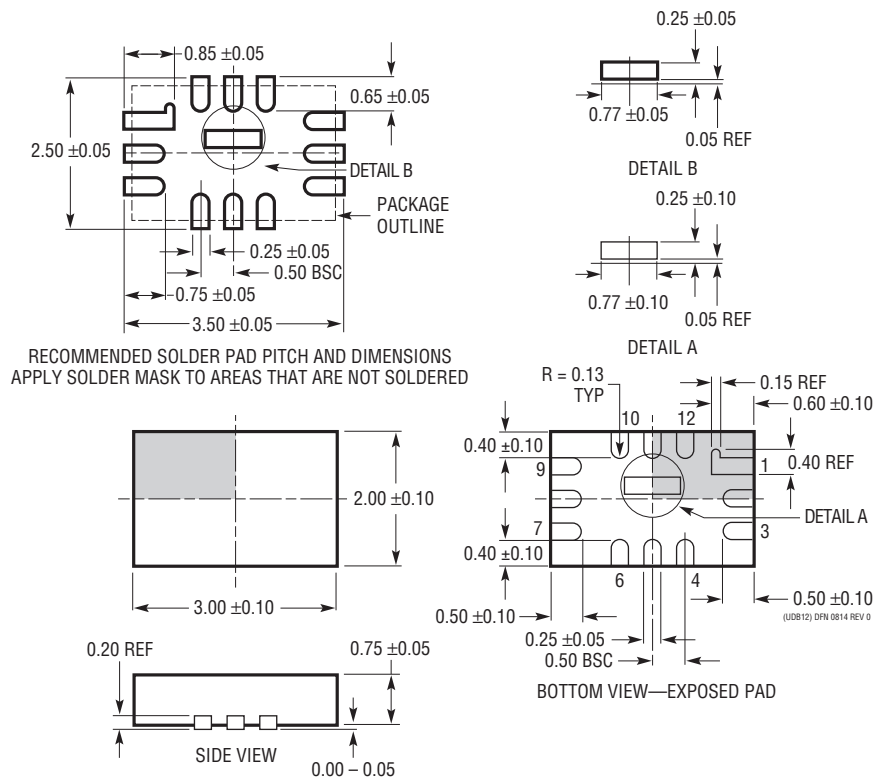

Figure 11. Comparison of the LTC5552 Performance Before and After De-Embedding the Insertion Loss of the Evaluation Board and SMA Connectors. Downconversion Application with Low Side LO, IF = 240MHz, $V_{CC} = 3.3V$, EN = High, $T_C = 25^\circ C$

PACKAGE DESCRIPTION

Please refer to <http://www.linear.com/product/LTC5552#packaging> for the most recent package drawings.

UDB Package Variation A 12-Lead Plastic QFN (3mm × 2mm) (Reference LTC DWG # 05-08-1985 Rev 0)



TYPICAL APPLICATION

Wideband Upconversion to 7.5GHz

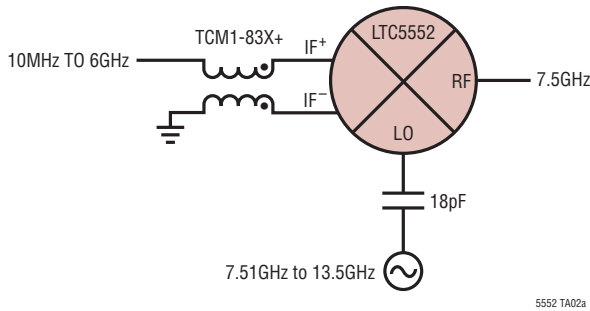

Conversion Loss and IIP3 vs Input Frequency (High Side LO)

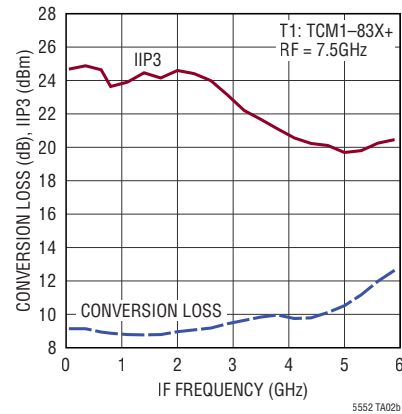

RELATED PARTS

PART NUMBER	DESCRIPTION	COMMENTS
Mixers, Modulators and Demodulators		
LTC5553	3GHz to 20GHz Microwave Mixer	9dB Conversion Loss, 24dBm IIP3, 500MHz to 9GHz Single-Ended IF with Integrated Balun
LTC5548	2GHz to 14GHz Microwave Mixer with Wideband DC-6GHz IF	7.1dB Conversion Loss, 24dBm IIP3, 3.3V/120mA Supply
LTC5549	2GHz to 14GHz Microwave Mixer	8dB Conversion Loss, 24dBm IIP3, 500MHz to 6GHz Single-Ended IF with Integrated Balun
LTC5544	4GHz to 6GHz Downconverting Mixer	7.5dB Gain, >25dBm IIP3 and 10dB NF, 3.3V/200mA Supply
LTC5576	3GHz to 8GHz High Linearity Active Upconverting Mixer	25dBm OIP3, -0.6dB Gain, 14.1dB NF, -154dBm/Hz Output Noise Floor, -28dBm LO Leakage at 8GHz
LTC5551	300MHz to 3.5GHz Ultrahigh Dynamic Range Downconverting Mixer	+36dBm IIP3; 2.4dB Gain, <10dB NF, 0dBm LO Drive, +18dBm P1dB, 670mW Power Consumption
LTC5567	400MHz to 4GHz, Active Downconverting Mixer	1.9dB Gain, 26.9dBm IIP3 and 11.8dB NF at 1950MHz, 3.3V/89mA Supply
LTC5577	300MHz to 6GHz High Signal Level Active Downconverting Mixer	50Ω Matched Input from 1.3GHz to 4.3GHz, 30dBm IIP3, 0dB Gain, >40dB LO-RF Isolation, 0dBm LO Drive
LTC5510	1MHz to 6GHz Wideband High Linearity Active Mixer	50Ω Matched Input from 30MHz to 6GHz, 27dBm OIP3, 1.5dB Gain, Upconversion or Downconversion
LTC5586	300MHz to 6GHz Ultra-Wideband Direct I/Q Demodulator with IF Amplifier	I/Q Bandwidth DC to 1GHz, +30dBm IIP3, 80dBm OIP2, Image Rejection >60dB, DC Offset Cancellation
LTC5588-1	6GHz I/Q Modulator	200MHz to 6GHz Direct Conversion, 31dBm OIP3 Adjustable to 34dBm, -160dBm/Hz Output Noise Floor, Excellent ACPR
Amplifiers		
LTC6430-20	High Linearity Differential IF Amp	20MHz to 2GHz Bandwidth, 20.8dB Gain, 51dBm OIP3, 2.9dB NF at 240MHz
LTC6432-15	High Linearity Differential IF Amp	100kHz to 1.4GHz Bandwidth, 15.9dB Gain, 50.3dBm OIP3, 3.2dB NF at 150MHz
RF Power Detectors		
LTC5564	15GHz Ultra Fast 7ns Response Time RF Detector with Comparator	600MHz to 15GHz, -24dB to 16dBm Input Power Range, 9ns Comparator Response Time, 125°C Version
LTC5582	40MHz to 10GHz RMS Detector	±0.5dB Accuracy Over Temperature, ±0.2dB Linearity Error, 57dB Dynamic Range
LTC5596	100MHz to 40GHz RMS Power Detector	35dB Dynamic Range (-37dBm to -2dBm), ±1dB Flatness from 200MHz to 30GHz
RF PLL/Synthesizer with VCO		
LTC6948	Ultralow Noise, Low Spurious Frac-N PLL with Integrated VCO	373MHz to 6.39GHz, -157dBc/Hz WB Phase Noise Floor, -274dBc/Hz Normalized In-Band 1/f Noise

5552f